

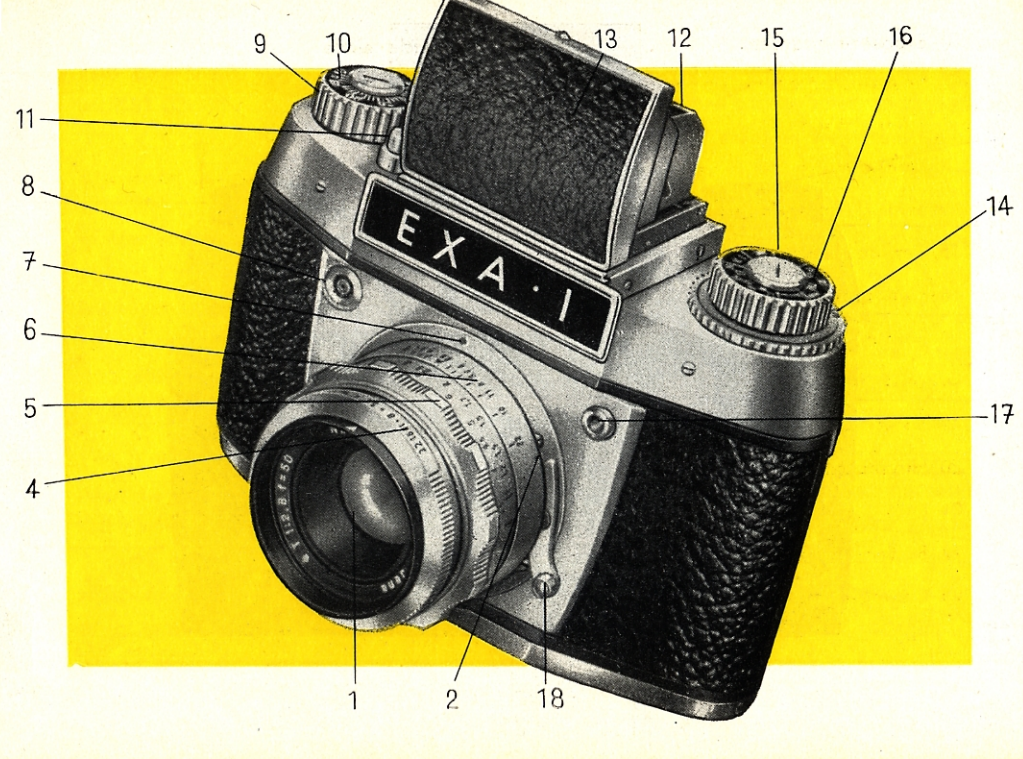

EXA·I

EXA·I

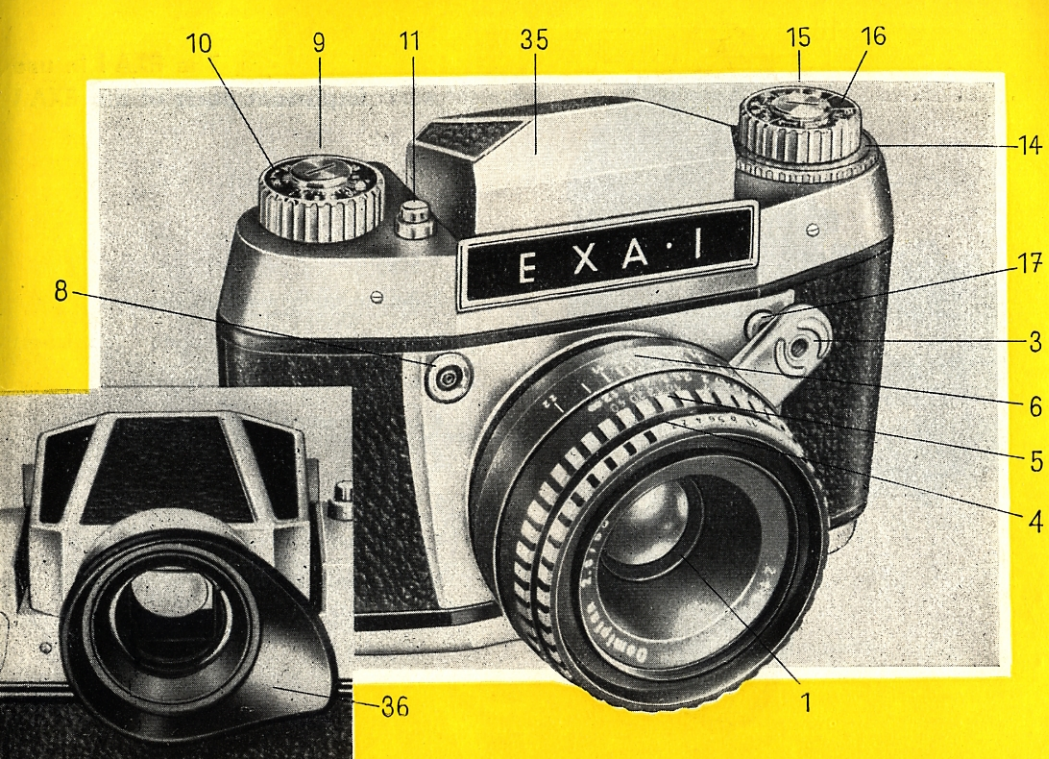





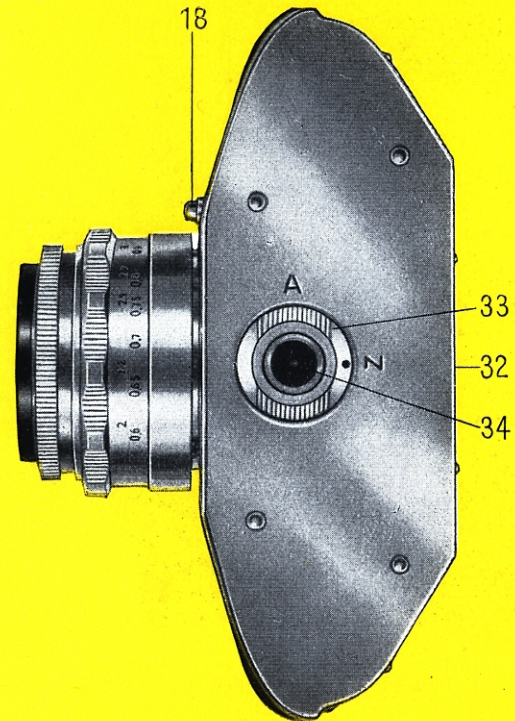
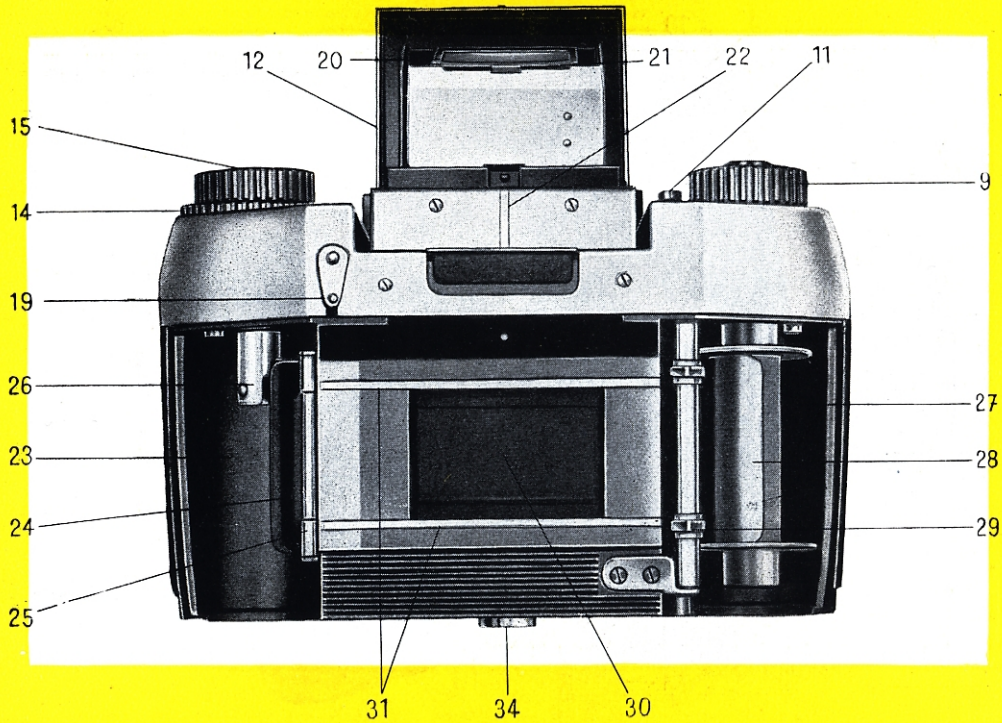



## The EXA I in use

### Important parts of the EXA I

- 1 Lens
- 2 Red locating mark on the lens
- 3 Diaphragm release button (on lenses with automatic diaphragms)
- 4 Lens aperture adjustment ring
- 5 Focusing ring
- 6 Depth of field scale
- 7 Red locating mark on the camera
- 8 Flash socket
- 9 Winding knob (which also tensions the shutter)
- 10 Exposure counter
- 11 Release button for rewinding the film
- 12 Finder Hood
- 13 Finder Hood (front section)
- 14 Shutter speed adjustment ring
- 15 Rewind knob
- 16 Film speed indicator
- 17 Shutter release button
- 18 Lens bayonet catch
- 19 Safety catch for shutter release
- 20 Hinged focusing magnifier
- 21 Grip for hinged focusing magnifier
- 22 Button for opening the Finder Hood
- 23 Chamber for cartridge of unexposed film
- 24 Guide plate
- 25 Film roller
- 26 Rewind knob shaft
- 27 Chamber for the take-up spool or cartridge
- 28 Take-up spool
- 29 Film transport sprocket
- 30 Image frame
- 31 Film guides
- 32 Removable camera back (with interchangeable pressure plate)
- 33 Knurled ring for locking the back
- 34 Tripod bush
- 35 Pentaprism
- 36 Eyepiece for pentaprism



## The EXA I 24×36 mm camera model 63

is now your property, and we congratulate you on the purchase of this camera. It will bring you a great deal of pleasure for not only it is simple to use but it is also quick and easy to operate. It is, therefore, a camera that is always ready for use.

You know, of course, that the main advantage of the EXA I is that it belongs to the family of single-lens reflex cameras. A small mirror is fitted inside the camera which reflects the image from the lens on to a ground-glass screen. The viewed image and the image recorded on the

film are both received through the taking lens, therefore, it can be understood that the image on the screen is free from any parallax error. In short it means that anything that is focused and can be seen on the ground-glass screen will be recorded on the film.

But in any case make sure that you read the instruction book fully before attempting to take photographs. Provided that the camera is operated correctly you will always take successful photographs and avoid upsetting the camera mechanism. It is best to turn the opposite pages of this leaflet to the left so that the general illustrations indicating the various parts of the camera can be referred to whilst reading the instruction book.



Before loading a film into the EXA I make yourself thoroughly familiar with the camera. Practise operating the shutter, removing and replacing the back, using the Finder Hood, finding the subject, and focusing. Handle the camera as though it were loaded. Right at the very end exercise the film loading. It is a good idea to

practise using the camera with an old or perhaps already exposed and developed film.

And now we wish you every success with your EXA I!

For any queries concerning your camera we are at your disposal with our advice and experience.

**IHAGEE KAMERAWERK AG · DRESDEN A 16**

## Removal and replacement of the camera back

Turn the knurled ring (33) on the base of the camera with the thumb so that the red index mark moves from "Z" to "A". Take the camera in both hands and withdraw the back (32) for about a quarter of an inch to the red point with both thumbs (Figure 1) and then lift it up out of the guides.

When replacing insert the back (32) – with the knurled ring (33) set at "A" – from above into the grooves on both sides of the case: upper edge of the camera back on red point (exactly the same as when removing the back, see Figure 1). Now push the back fully home. Turn the ring (33) from "A" to "Z".



Fig. 1

## Opening and closing the Finder Hood

To open the Finder Hood (12) press the button (22). To close the hood press the front (13) backwards until it locks. To raise the focusing magnifier (20) press the grip (21) upwards; to lower the magnifier press the grip downwards.

There is more about the use of the Finder Hood on page 13. The image is only visible on the ground-glass screen if the shutter is tensioned. To tension the shutter see next paragraph.

## Film transport and shutter tensioning

are coupled (no double exposures and no blank film).

With the shutter release safety catch (19) raised (Figure 2) it is possible to release the shutter either by directly pressing the shutter release (17) or by pressing the dia-

phragm release button of the lens (3) which in turn operates the shutter release.

With the shutter release safety catch (19) turned to the left (red dot visible) it is impossible to release the shutter. This prevents accidental release of the shutter during storage or while the camera is being carried about.

Film transport and shutter-tensioning is achieved by turning the winding knob (9).

Fig. 2

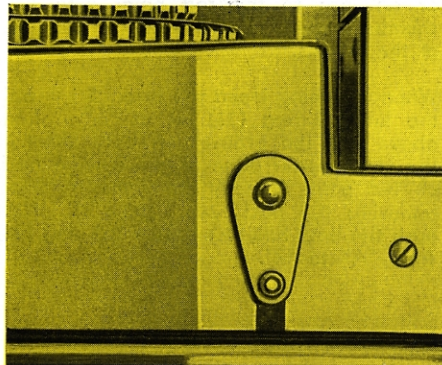

Always turn this knob after operating the shutter clockwise and **as far as possible**. This is important for the operation of the exposure counter and for the full transport of the film. It is impossible to turn the knob (9) before the shutter has been released.

When you have finished taking photographs remember to set the shutter release safety catch (19) to the left.

Fig. 3

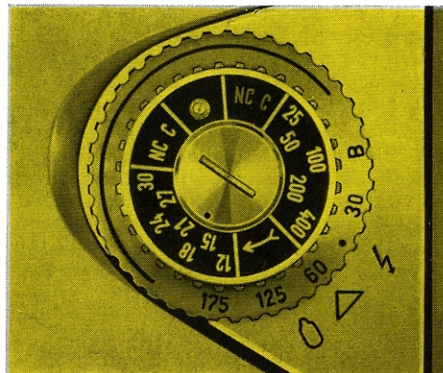

## Operation of the shutter

**Instantaneous exposures:** Turn the shutter speed ring (14) until the required speed is exactly opposite the engraved triangle (Figure 3). It is impossible to turn the speed setting ring past 1/175 or "B" because there is a stop limit on these values. The numbers on the shutter speed ring signify fractions of a second, e. g. 60 = 1/60th second. It is impossible to select shutter speeds between those shown on the ring (14).

The camera can be "hand held" with all four instantaneous exposure times. Longer exposures using the "B" setting are possible only with camera mounted on a tripod or supported firmly. The tripod bush (34) is on the base of the camera.

**Time exposures:** Set the shutter speed ring (14) to "B". The shutter will open when the shutter release (17) or the diaphragm release button (3) is pressed and it will re-



main open as long as either button is held depressed. However, for very long exposures it is convenient to be able to leave the camera with the shutter open. Set the shutter speed ring (14) to "B", open the shutter by pressing the shutter release button (17) or the diaphragm release button (3) and then set the safety catch (19) by turning it to the left. The shutter will now remain open until the safety catch is raised. This method of time exposure is ideal for very prolonged exposures. When the camera is fitted with a Domiplan f 2.8 50 mm lens it is impossible to use the method given above because after the safety catch is set the diaphragm re-opens. For prolonged exposures with this lens it is advisable to use a cable release which incorporates a locking device. For further information see page 10. "B" and "T" settings are most important for night and indoor photography.

When making time exposures it is a good idea to use a cable release particularly on the "B" setting. The cable release will screw into either the shutter release button

(17) or as already stated into the diaphragm release button (3) on the lens.

It is most important that the camera should be firmly supported during time exposures.

The ideal way, of course, is with a tripod, but a table or wall will sometimes suffice. It is possible to alter the shutter speed before or after tensioning the shutter.

Marketable automatic releases can be attached to the cable release or screwed into the shutter releases (17 or 3).

### Operation of the lens

To remove the lens (1) press the bayonet catch (18) towards the lens. Turn the lens counter-clockwise (Figure 4) until the red dots (2 and 7) are opposite each other, then lift out the lens. To replace the lens reverse the sequence of operations. Insert the lens, making sure that the red dots are adjacent. Turn the lens clockwise as far as the stop.

There are special lenses available but there are some restrictions when using long focal length lenses. For further details see page 31.

Focusing is achieved by turning the focusing ring (5) which is marked in either metres or feet. Inspect the image on the ground-glass screen of Finder Hood or Pentaprism and turn the focusing ring (5) until the subject appears to be sharp. The distance of the subject can be ascertained by noting the distance shown on the red scale. These distances are measured from the back of the camera to the subject.

Set the diaphragm with the lens aperture adjustment ring (4). A low number, for example f 2.8, f 4, means that the diaphragm is set for a wide opening which in turn means that a fast shutter speed will probably be used. But a high number, for example f 16, f 22, indicates that the diaphragm is set to a small opening which necessitates the use of a slower shutter speed. However, a small aperture gives an improved depth of field.

Depth of field: The lens focuses most sharply those parts of the subject which are exactly the distance at which the lens is focused. However, this optimum sharp-

Fig. 4

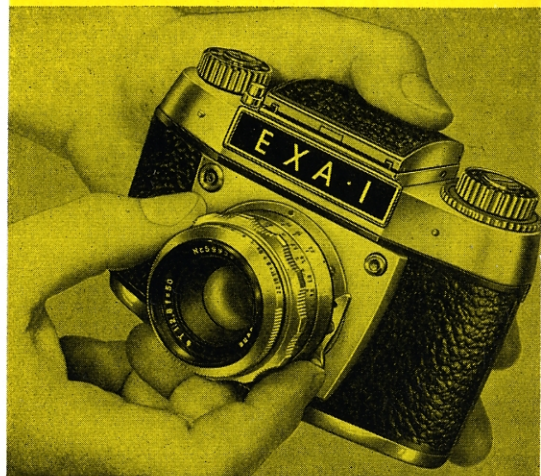



ness slowly falls off in front of and behind the focused distance. But there is a zone in which everything is acceptably sharp. This zone is known as the "depth of field". The EXA I has a depth of field scale which indicates the limits of the zone of acceptable sharpness. On either side of the red focusing index is engraved the sequence of aperture numbers. Note the aperture to which the diaphragm has been set. Now with this aperture number in mind, see what distances are indicated opposite the aperture number on either side of the red index mark. Anything that lies between these distances will be within the zone of acceptable sharpness. It will be seen that the smaller the aperture number the more will be acceptably sharp and that if the aperture number to the right of the index mark is opposite infinity ( $\infty$ ), then the depth of field will extend to infinity.

Here are three examples:  
With the focus ring set to  $\infty$  (infinity) and

the aperture set at f 11, then the depth of field reaches from just over 15 feet to infinity (see Figure 5).

With the focus ring set to 15 feet and the aperture set at f 8, then the depth of field reaches from approximately 10 feet to 50 feet (see Figure 6).

With the focus ring set to about 6 feet and the aperture set at f 5.6, then the depth of field reaches from about 5 feet to 8 feet (see Figure 7).

The lenses are fitted with one of three aperture systems — click stops, pre-set or automatic. When focusing always set the diaphragm at its widest aperture (bright image on the ground-glass screen) and only shut down the diaphragm just before making an exposure. There is no need to move the camera from the taking position with any of these systems.

**Click stops of the Jena T f 2.8 50 mm lens (Figure 5)**

As the lens aperture scale is turned a series of clicks are audible. Each click

represents one stop on the scale and takes place as the numbers pass the index mark. When shutting down the lens merely count the number of clicks until the desired aperture is set. It can be seen, therefore, that it is unnecessary to move the camera from the taking position.

**Use of the pre-set diaphragm of the Meritar f 2.9 50 mm lens (Figure 6)**

Press back the knurled ring behind the lens aperture ring towards the camera body and turn the lens aperture adjustment ring until the required f-number is opposite the red dot. Let the knurled ring spring

Fig. 5



Fig. 6

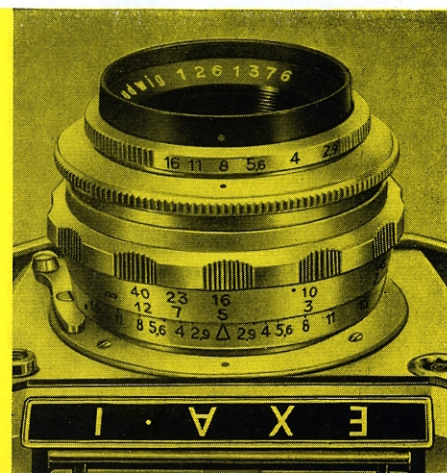



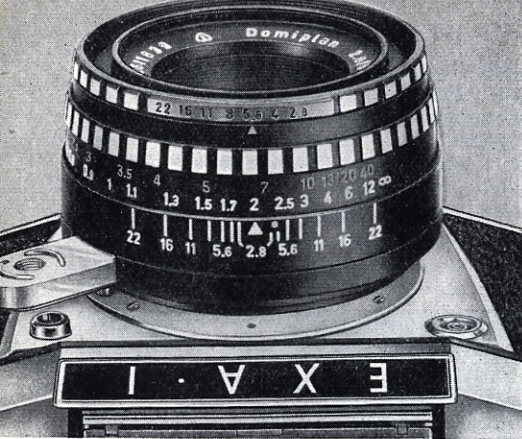

Fig. 7

back to its original position. To focus: open the diaphragm fully and only just before releasing the shutter turn the lens aperture ring as far as possible without moving the camera from the taking position. The aperture ring will stop at the pre-selected aperture.

### Fully automatic diaphragm of the lens Domiplan f 2.8 50 mm (Figure 7)

The automatic diaphragm is always fully open to focus and to view the reflex image. Pre-set the required aperture by turning the lens aperture adjustment ring (at the very front); the f-number must be opposite the red indicator triangle. Intermediate values between two f-numbers can also be selected. By pressing the diaphragm release button (3) it is automatically stopped down. When the shutter is released the diaphragm automatically re-opens to the widest aperture. Do not release the pressure on the button until the shutter has completed its cycle of operation. If time exposures are necessary when using this lens fit a cable release which incorporates a locking device. Set the shutter speed ring to "B", press the cable release and lock it in the depressed position. In this way pressure is maintained on the diaphragm release button during the exposure period without the necessity of having to hold the release by hand. It is also an added safeguard against camera shake.

To check the depth of field while focusing, depress the diaphragm release until the diaphragm shuts down to the selected aperture and no further.

### Fully automatic diaphragm of the Jena T f 2.8 50 mm lens (Figure 8)

Focusing is carried out by turning the front ring (focusing ring).

There are, however, two methods of controlling the lens aperture: either automatic or manual.

Setting for automatic: So that the diaphragm may be operated automatically it must be correctly set. With its mount the release button (3) of the lens must project about half an inch to the rear. To bring the ring into the automatic position press the mount with the release button towards the camera body and turn it clockwise (looking at the camera from the front). The mount and release button then spring into the automatic position.

Setting for manual: To return the diaphragm control to manual operation press

the mount with the release button in towards the camera and turn it counter-clockwise. Once this operation has been carried out it is possible to alter the aperture setting by turning the lens aperture adjustment ring (just in front of the body).

Fig. 8

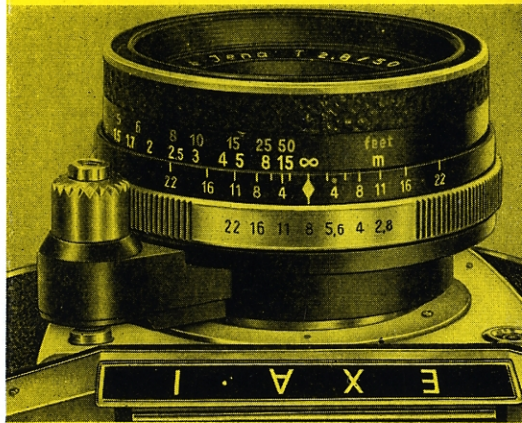

The aperture setting will remain closed regardless of shutter operation (important for long exposures). The aperture control is continuously variable so that aperture settings between those marked on the scale can be used if necessary. The setting required is merely set against the red index mark.

The diaphragm release button can be adjusted to make sure that it operates the shutter release correctly. Adjustment is by means of a screw on the bottom of the diaphragm release which can be adjusted with a screwdriver as necessary.

When using the automatic diaphragm device the diaphragm is at the widest aperture for critical focusing and composition of the picture. The diaphragm is closed when the diaphragm release button (3) is pressed. The exposing aperture at which the picture is taken must be set on the aperture setting ring before focusing. The pressure applied to the diaphragm release button (3) closes first the diaphragm to the pre-selected aperture, and then operates the shutter. When the pressure is

released the diaphragm automatically opens to the widest aperture of the lens. It is important not to release the diaphragm release button (3) until the shutter has completed its cycle of operation. It is a good idea to use manual operation of the diaphragm when long time exposures are involved. A cable release can be screwed into the diaphragm release button.

To check the depth of field while focusing, but with the diaphragm release set on automatic, press the diaphragm release button (3) until the diaphragm closes to the pre-selected f-number. Do not press any further or the shutter will be released.

#### **Focusing for infra-red photography**

If the camera is loaded with infra-red film the focusing procedure is a little different from normal. First of all focus on the ground-glass screen in the normal way. Note the distance indicated opposite the red index mark. Turn the focusing ring until the indicated distance is opposite the small red dot which is on the right or left of the red index mark. By this means the image produced by the infra-red light is

critically focused. It is necessary to re-adjust the focusing ring because the infra-red light produces a sharp image behind the film plane when the focus is correct for white light. The slight adjustment of the focus thus brings the infra-red image into critical focus and, therefore, renders a sharp negative on the infra-red film.

#### **Operation of the Finder Hood**

A bright, upright and magnified image appears on the ground-glass screen visible in the Finder Hood (12) of the EXA I. It facilitates composition and focusing, as well as enabling the depth of field to be determined when the exposing aperture is set. Normally the picture is composed by using the magnifying ground-glass screen and then focused critically with the help of the hinged focusing magnifier (20). The magnifier is in the focusing position when the Finder Hood is opened, but it can be locked in the rest position with the grip (21), see also page 4.

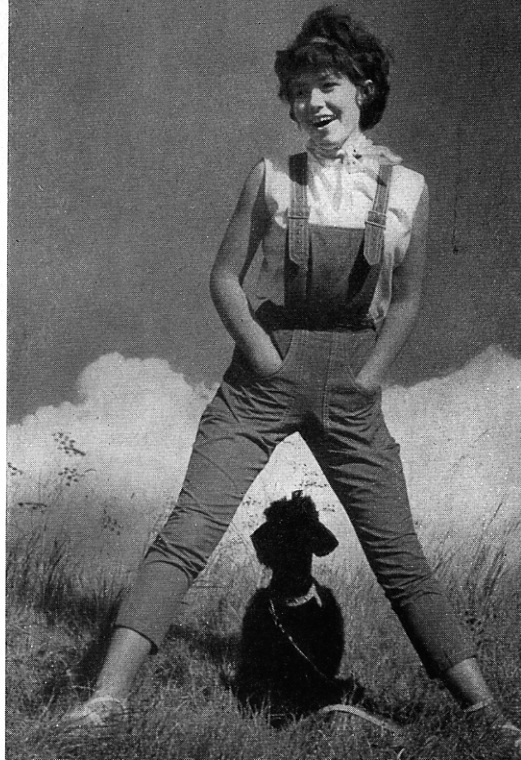





Fig. 9

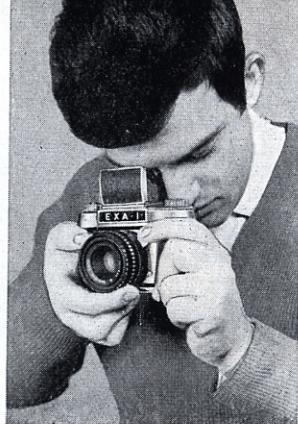

Fig. 10

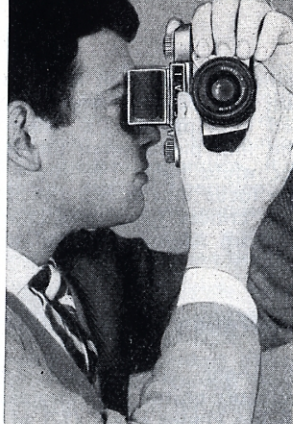

Fig. 11

In the normal way the EXA I is held at chest or shoulder height (Figure 9). Figures 10 and 11 show the position of the camera when using the focusing magnifier. For vertical shots with the Finder Hood the photographer stands at right angles to the subject (Figure 11). This is particularly useful when the photographer

wants to remain unobserved (Figure 12). The Pentaprism, however, enables you to take vertical photographs standing in a normal position and the visible image is not only upright but laterally correct as well (see next paragraph). It is possible to focus the image while holding the camera with the Finder Hood above the

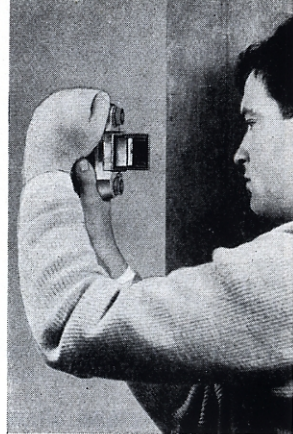

Fig. 12

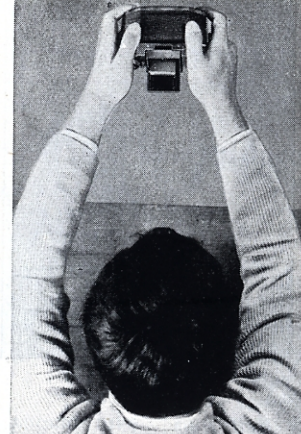

Fig. 13



Fig. 14

head (Figure 13). Holding the camera in this way is admirable for taking photographs over walls, crowds, etc. The EXA I is a versatile camera. The Finder Hood can be removed so that if desired — as already mentioned — a Pentaprism (36) can be fitted. Before removing the Finder Hood (12) it should be closed. Then lift it.

To replace the Finder Hood insert it vertically and press it down until it clicks home. On no account use force!

People who wear spectacles should wear their reading glasses to focus when the Finder Hood is fitted to the camera.





Fig. 15

Fig. 16

Fig. 17

## Use of the Pentaprism

The Pentaprism (35) is an important attachment for the EXA I and it is supplied separately as an accessory. It is particularly useful for sport and other fast-moving subjects.

Once the Pentaprism is fitted the camera is always held at eye level. The Penta-

prism is fitted to, and removed from, the camera in exactly the same way as the Finder Hood. For both vertical and horizontal pictures the image is upright and laterally correct. This is particularly important when taking pictures of fast moving subjects, because any movement across the screen is in the same direction as in reality. This simplifies smooth panning of

the camera with very fast moving subjects such as motor racing.

When the EXA I is fitted with the Pentaprism (35) hold the camera in the right hand and focus with the thumb and forefinger. Use the left hand to give additional support. Release the shutter with the left forefinger (Figures 15 and 16). However, it is possible to invert the camera when taking horizontal pictures. In this case the camera back is pressed firmly against the forehead to help eliminate camera shake (Figure 17).

People who wear spectacles should take their long distance glasses to focus when the Pentaprism is fitted to the camera.

The rubber eyepiece (36) is highly recommended and is an almost indispensable accessory. It is fitted to the eyepiece of the Pentaprism and excludes extraneous sidelight. The rubber eyepiece can be fitted with a correction lens by an optician so that the camera can be focused without the need for spectacles.

## Interchanging the ground-glass magnifier and use of the split-image rangefinder (distance meter)

The magnifying ground-glass screen of the focusing assemblies of the EXA I can be lifted out. Before lifting out the ground-glass screen from the Finder Hood, make sure that the focusing magnifier (20) is in the rest position and that the Finder Hood is closed.

Remove the focusing assembly from the camera. Grip the long sides of the ground-glass screen and lift it out of the assembly. To replace the screen, grip the long sides as before and press it home between the clamping springs of the focusing assembly. Do not touch the surface of ground-glass screen.



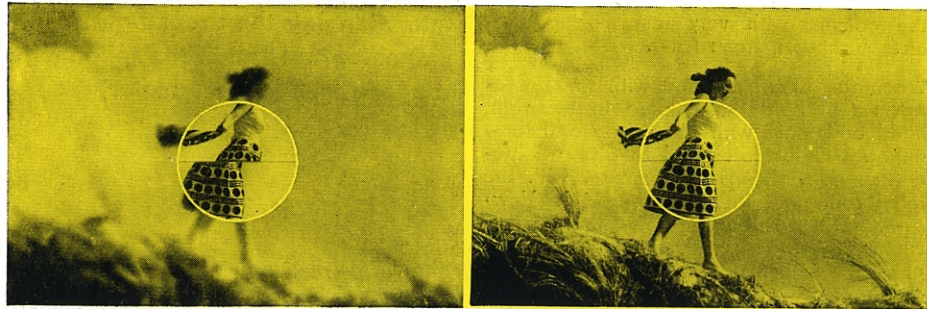

Fig. 18

Instead of the ground-glass screen it is possible to fit, both to the Finder Hood and the Pentaprism, a screen which incorporates a split-image rangefinder (Figure 18). It is particularly useful in con-

ditions of poor visibility or bad light. When the subject is correctly focused the two halves of the subject within the central panel coincide. Do not use an aperture smaller than  $f\ 5.6$  for focusing.





## Loading the film

Size of film: perforated 35 mm film (DIN 4535/4536). There are 36 exposures 24×36 mm on a film length of 5 ft 5 in. (1.60 m). Remove the back (32) as described earlier. Insert the cartridge of unexposed film into the chamber (23) from below (Figure 19) and if necessary turn the rewind knob (15) slightly until the rewind knob shaft (26) engages with the cartridge film spool. The lips of the cartridge must be in such a position that the leading edge of the film is on the guide plate (24). Remove the take-up spool (28) from the take-up chamber (27). Insert the end of the film between the securing spring of the take-up spool (Figure 20), give the spool half a turn to start the film winding. Put the

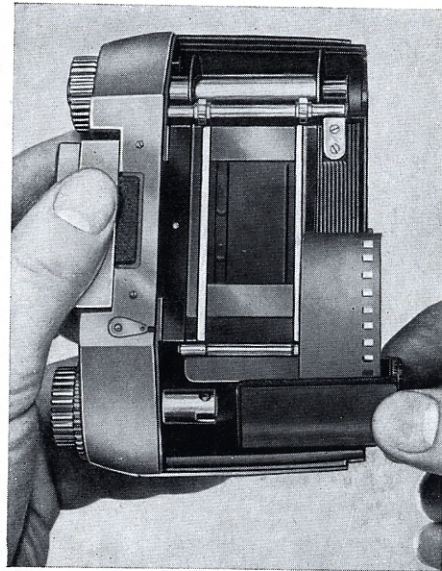

Fig. 19

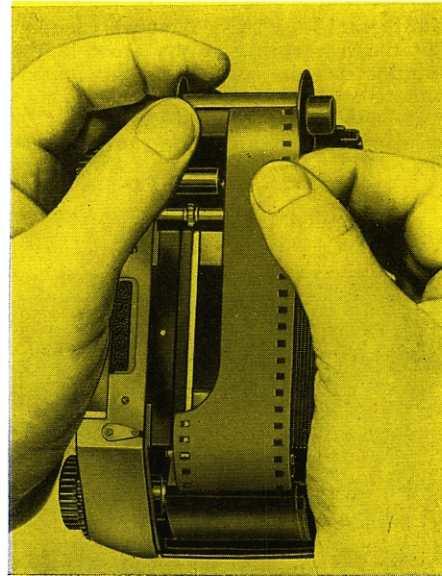

Fig. 20

take-up spool (28) into the take-up chamber (27), turn the take-up spool (in the take-up direction) until it engages with the shaft (26) of the winding knob (9). Push the spool fully into the take-up chamber.

Now turn the winding knob clockwise (if necessary release the shutter) until the film is taut from the full cartridge over the film roller (25) and the film guides (31) to the film transport sprocket (29). The teeth of the film transport sprocket (29) must engage the perforations of the film (Figure 21).

Replace the back (32) as described and set the knurled ring (33) on "Z". Wind on twice as far as possible by turning the winding knob (9) and releasing the shutter as necessary. Turn the exposure counter (10) in the direction of the arrow and set it on "36" or "20" (see Figure 22) depending on the film being used, i. e. always set it at the highest number available on the film length. The EXA I is now ready for photographs and the film coun-



ter shows after each exposure how many more exposures can be made on the film.

In place of the take-up spool (28) an empty film cartridge can be placed in the take-up chamber (27). Attach the end of the film to the centre spool of the cartridge. The spool must be fitted in the

cartridge the opposite way to normal so that the take-up knob shaft will engage with the film spool. Fit the spool in the cartridge and the cartridge in the camera so that the spool is correctly engaged with the winding knob shaft. Make sure that the film is taut from cartridge to cartridge (Figure 23).

Any of the standard shapes can be used with the EXA I take-up spool. The take-up spool will also accept the straight edge if you are loading the camera from bulk rolls of film. When using a take-up cartridge the film must be cut to fit the centre of the spool (film trimming see Figure 24).

When the film is being wound on in the normal way the rewind knob (15) turns together with the incorporated film speed indicator (16).

Immediately after loading the camera set the film speed indicator as a reminder of the type of film in the camera. Turn the

Fig. 21

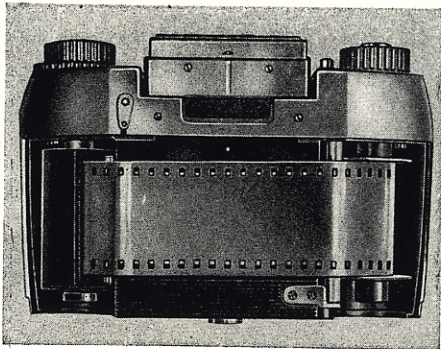

Fig. 22

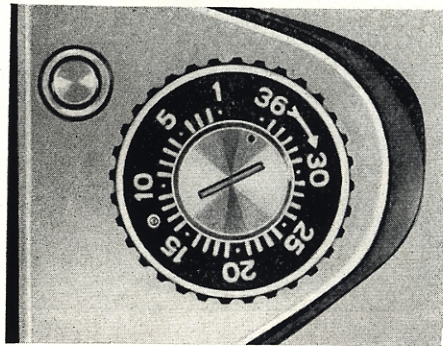

Fig. 23

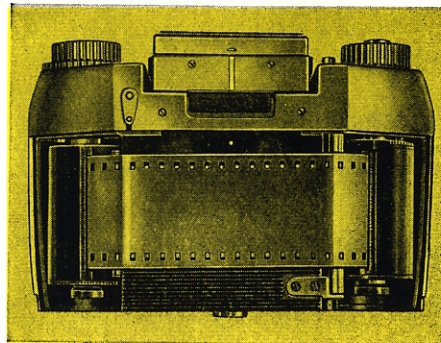
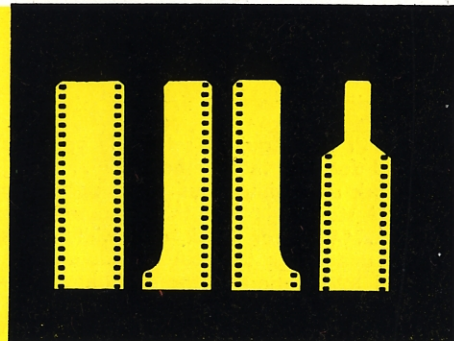

Fig. 24





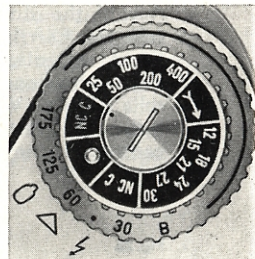
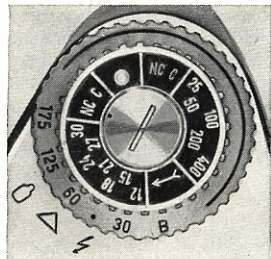
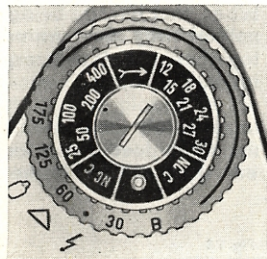
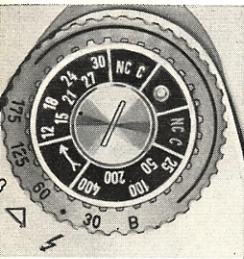

Fig. 25

Fig. 26

Fig. 27

Fig. 28

disc until the required setting is opposite the red dot. Use the numbers "12" . . . . "30" for black and white films rated according to DIN standards and the numbers from "25" . . . . "400" for black and white films rated according to ASA standards etc. The white lettering is for daylight colour film ("C" = reversal film; "NC" = negative film), the red lettering is for film

balanced for artificial light ("C" = reversal film, "NC" = negative film). Here are four examples:

- 18<sup>0</sup> DIN (black and white film) – Figure 25,
- 200 ASA (black and white film) – Figure 26,
- Negative colour film for daylight – Figure 27,
- Reversal colour film for artificial light – Figure 28.

## Removing the film

When using a take-up spool one or two more exposures possibly can be made after the 36th photograph. The film is finished when the winding knob (9) cannot be turned fully and resistance is felt before the shutter has been fully tensioned. To rewind the film take the camera in the left hand and press the rewinding button (11). Turn the rewind knob (15) in the direction of the arrow (Figure 29) until it is noticeable that the turning of the knob is much easier. The film is now completely rewound. Check that the winding knob (9) has been turned as far as possible so that the shutter is fully tensioned. Remove the camera back (32) and remove the cartridge of exposed film from the camera.

Fig. 29





If a take-up cartridge is used the procedure is slightly different. After the last exposure wind on once more and release the shutter. Wind on again if possible to make sure the 36th or 20th exposure is well inside the take-up cartridge. Remove the back of the camera and cut or tear off the film. Remove the take-up cartridge from the camera and wind the film end into the cartridge.

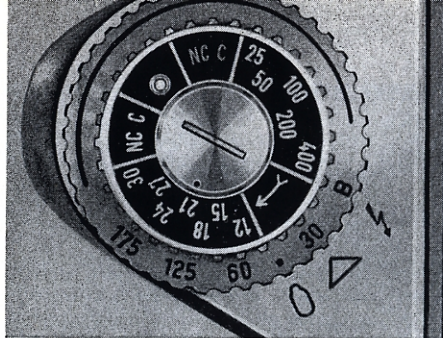

Fig. 30

## Flash photography

The EXA I has a flash connection (8) with symbol indication of the appropriate shutter speeds intended for flash photography.

For F-type (short burning) flash bulbs turn the shutter-speed adjustment ring (14) so that the flash bulb symbol (⚡) is opposite the red dot (Figure 30). The shutter is thereby set for 1/30th second.

If other flash bulbs with longer flash durations are used, the shutter must be set

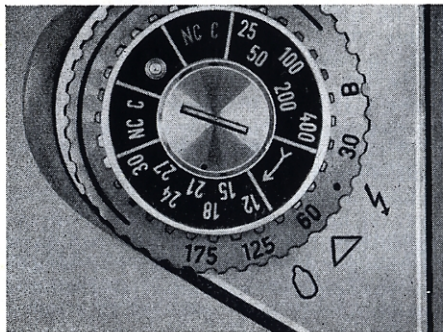

Fig. 31

Osram Flash bulbs			Philips Photoflux Flash bulbs			RFT Photo Flash bulbs		
Type	Guide Number 170 D(Nx)	Flash Duration	Type	Guide Number 17 D(Nx)	Flash Duration	Type	Guide Number 170 D(Nx)	Flash Duration
XM 1	30	$\frac{1}{100}$ s	PF 1	30	$\frac{1}{100}$ s	X 1	18	$\frac{1}{200}$ s
XM 5	50	$\frac{1}{80}$ s	PF 5	50	$\frac{1}{80}$ s			

x) Black and white film only

on "B". The shutter release (17) or the diaphragm release button (3) must be set free immediately after the flash has been fired so that the shutter closes. If the shutter is left open too long the room lighting will begin to affect the film.

When the camera is being used with electronic flash turn the shutter speed ring (14) so that the flash symbol (⚡) is opposite the red dot (Figure 31). The shutter is thereby set for 1/60th second. However, electronic flash can only be used with

normal image distances (distance between lens and film). When using extensions (bayonet rings and tubes) for close-ups and long focal length lenses electronic flash can only be used in conjunction with the "B" setting of the shutter. The basic method of working is the same as has been described for flash bulbs. (Electronic flashes with mains supply working without capacitor must be synchronized with the shutter being set to "B".) The shutter speed of 1/30th second cannot be used for electronic flash as it has been



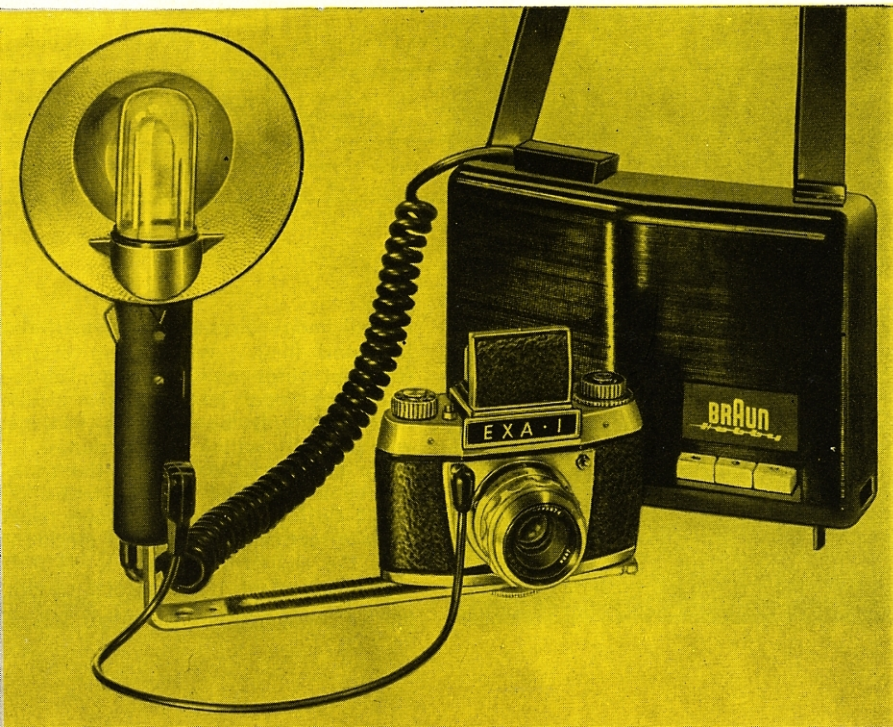

synchronized exclusively for flash bulbs, and the synchronization allows for their delayed ignition time.

With the EXA I only the open flash technique is employed, i. e. the flash is fired while the shutter is held open. The cable of the flash holder for flash bulbs or of the electronic flash unit is connected to the flash socket (8). The shutter must be tensioned beforehand. Figure 32 shows the EXA I being used in conjunction with an electronic flash unit.

If for some reason the flash bulb does not fire, e. g. through poor contact at the socket, then remove the flash bulb before winding on again. Only insert new flash bulbs after tensioning the shutter.

### Care of the camera and the lens

Always store the camera with the lens and focusing insert fitted. Alternatively a protection cover can be fitted in place of the

lens. Keep the camera in the ever-ready case or wrapped in a lintless cloth. Keep all the external parts of the camera clean and free from dust; use a soft brush when necessary. Take particular care to brush the film track and film guides (31), the film roller (25), the film transport sprocket (29), the chambers (23 and 27) as well as the back (32) with the film pressure plate.

Only dust the camera mirror when absolutely necessary and only then with an extremely soft brush and do not apply unnecessary pressure. Take care not to touch the lightly greased metal mount of the mirror with the brush! Protect the camera from damp or dusty conditions and from flying sand, etc. Never handle the lens surfaces, the ground-glass screen or the mirror. Clean glass surfaces when necessary with a very soft chamois leather or soft lintless cloth and avoid too much pressure. Under no circumstances tamper with the camera mechanism. Have any repairs carried out either through your local agent or at the factory.



## Accessories

Accessories increase the scope of the EXA I and for many types of work they are indispensable.

### Leather ever-ready case

An ever-ready case affords excellent protection both when the camera is in use and when it is being stored. With this type of case the camera is always ready for instant use. The case has a tripod bush so the camera can be fitted to a tripod without removing it from the case.

### Lens hood (Figure 33)

A lens hood is indispensable for shots against the light and gives protection from side-light also. It is particularly important for colour photography. Another purpose of the lens hood is that it protects the lens surface from raindrops and snowflakes. Our lens hoods are of the

most efficient design, that is rectangular and are supplied with a screw-in fitting. The following sizes are available:

Diameter of thread	Thread	Outside lens-mount diameter
35.5 mm	0.5 mm	37 mm
40.5 mm	0.5 mm	42 mm
49 mm	0.75 mm	51 mm

### Giant release button (Figure 33)

It enlarges the pressure surface of the shutter release. This accessory is most useful in the winter because the shutter can be operated while wearing gloves.

### Polarizing filter

This is a special filter which eliminates reflections from nonmetallic surfaces such as glass, water, paint, etc. The filter is supplied in a screw-in mount. It eliminates reflections coming at an acute angle (for glass about  $35^{\circ}$ ). Rotate the filter until

the objectionable reflections are eliminated. The effect of the filter can be viewed and controlled by looking in the viewfinder. (About 2...3fold exposure time increase).

### Interchangeable lenses

Without special lenses photography is scarcely worth considering and the EXA I, in spite of its low price, is a highly versatile single-lens reflex camera. The composition, sharpness, and depth of field seen on the ground-glass screen determine the result of every photograph.

Wide angle lenses (with short focal length) have a wide field of view. A great deal is included in the picture area but naturally everything is reduced in size. This type of lens is intended primarily for indoor photography where space is limited. They are indispensable for surveys of landscapes, for reproductions in galleries, and for architectural photography.

Long focal length special lenses and telephoto lenses apparently bring distant ob-



Fig. 33





jects nearer. It can be seen, therefore, that they include less in the picture area. Telephoto lenses tend to give a more acceptable perspective. This type of lens has many uses, photographs of wild life, people and children, portraits, sport as well as landscapes. However, there are some limitations regarding the use of long focal length lenses with the EXA I, details of which are given on page 35. The normal lens is removed as described and the special lens is put in its place. The distances shown on the interchangeable lenses are measured from the back of the camera to the subject.

#### **Bayonet rings and tubes**

Close-ups are one of the strong points of a single-lens reflex camera. For in this field one relies again on the image visible on the ground-glass screen. Bayonet rings and tubes are fitted in any combination between the camera and the lens (Figure 34) and allow close focusing at short subject distances. The following

items can be supplied: a two-in-one ring which gives an extension of 5 mm, a set of bayonet rings and tubes. The two bayonet rings together give an extension of 10 mm and the tubes give additional extensions of 5, 15, and 30 mm. But naturally there is a limit to the number and length of the tubes that can be used. For further information see page 35.

#### **The auto-couple extension release**

This accessory connects the shutter release button and the diaphragm release of lenses with automatic diaphragms (e.g. the Domiplan f 2.8 50 mm) when extension tubes are being used for close-up work (Figure 34).

#### **Stereo attachments (Figure 35)**

These attachments enable three-dimensional pictures to be taken with the EXA I. The large stereo attachment (base 65 mm) is designed for photographing subjects



Fig. 34





Fig. 35

between ( $\infty$ ) and 6 ft (2 m). The small stereo attachment (base 12 mm) is intended for subjects between 6 ft and 6 in. (2 m and 0.15 m). For focusing at very short distances three supplementary lenses are supplied for the small stereo attachment. The stereo attachments can only be used with standard lenses of 50 mm focal length; the Jena T f 2.8 50 mm with click stops or with fully automatic diaphragm is suitable. The stereo attachment is screwed to the front of this lens. It may also be mounted on other lenses of 50 mm focal length and similar mounts with a suitable adapter ring. Screw the stereo attachment into the lens mount and lock it into position by turning the securing ring in the opposite direction. Before tightening the securing ring finally, check that the line separating the two images visible in the viewfinder is exactly perpendicular, i. e. parallel to the long sides of the half images. A second check on the vertical adjustment is to note a fixed point in both images and make sure that it is the same distance from the bottom edge of

the picture. Focus, as usual, according to the ground-glass screen. When using the stereo attachment increase the exposure 1 1/2 times. Because both images are adjacent the EXA I can only be used in the horizontal position to produce upright stereo pictures.

So as to be able to judge the effect of the stereo photograph accurately before exposure, fit the stereo insert "Stereflex" on to the EXA I. When it is fitted the image on the ground-glass screen is seen three-dimensionally. The "Stereflex" can also be used as a simple stereo viewer for stereo transparencies. When it is used as a viewer the magnifying ground-glass screen must be removed. Grip the long sides of the screen and pull it out of the clamping springs. Next fit the frame which is supplied on to the stereo insert. Engage the studs on the frame with the clamping springs of the "Stereflex".

## Limitations of use of the EXA I

The EXA I is a single-lens reflex camera which is excellent value at a surprisingly low price. This is only possible because a relatively simple shutter is installed. A simple shutter naturally imposes a few limitations in the use, but the majority of people will not find these restrictions irksome.

When using bayonet rings and tubes, distances greater than 70 mm between lens and film plane will cause some cut-off on the long sides of the negative. The cut-off is insignificant when using the normal lens with extensions of about 20 to 50 mm; a sufficiently large area of the negative is usable. However, we advise against longer extensions (e.g. with our bellows attachments).

The same cut-off can occur when using long focal length lenses. When using long focal length lenses of normal design up to 100 mm the cut-off will be negligible; but focal lengths of more than 100 mm

will give more serious cut-off. (Telephoto lenses give better results). We recommend that you check the selected long focal length lens for cut-off by placing a piece of ground glass at the image frame (30) of the camera.

The shutter installation also places some limitations on the use of electronic flash. When extension tubes and long focal

length lenses are being used it is not possible to synchronize the electronic flash with the fast shutter speed of 1/60th second. It is, therefore, necessary, as has already been described, to use the "B" setting of the shutter. We repeat here that the shutter speed of 1/30th second is for use with type-F flash bulbs only and cannot be used with electronic flash equipment.

If you wish to have still more detailed information, please refer to your photographic dealer or ask our Publicity Department for information and special leaflets. Write to us whatever your interests.

The illustrations in this booklet may differ in detail from the cameras and the accessories supplied.

**IHAGEE KAMERAWERK AG · DRESDEN A16**



IHAGEE KAMERAWERK AG · DRESDEN A 16